

PLANNEN WONING

Eeklo, Oostveldstraat

LOT 2-3

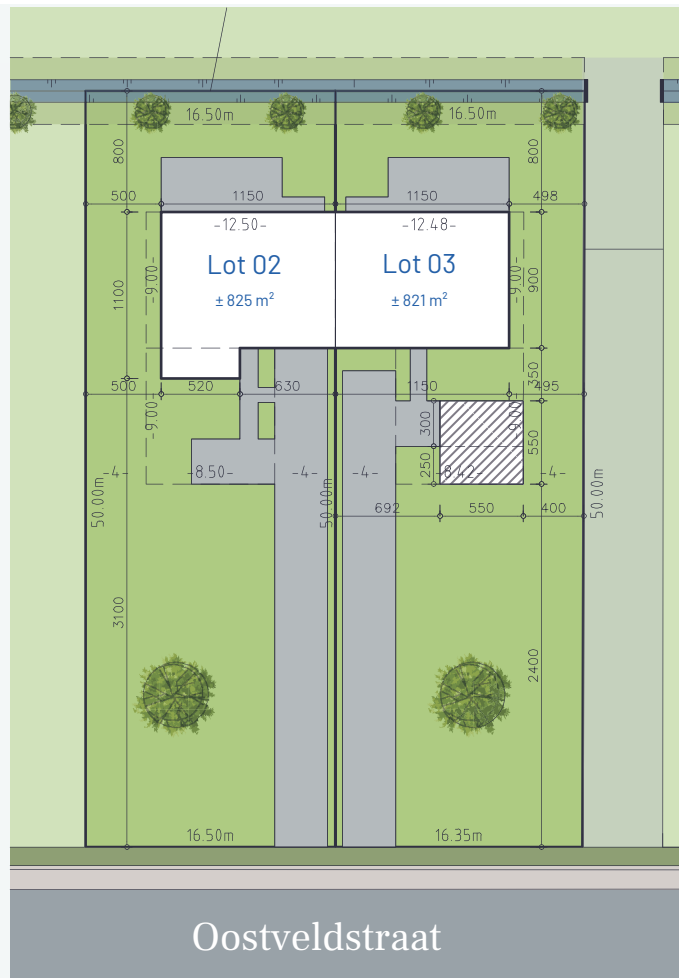



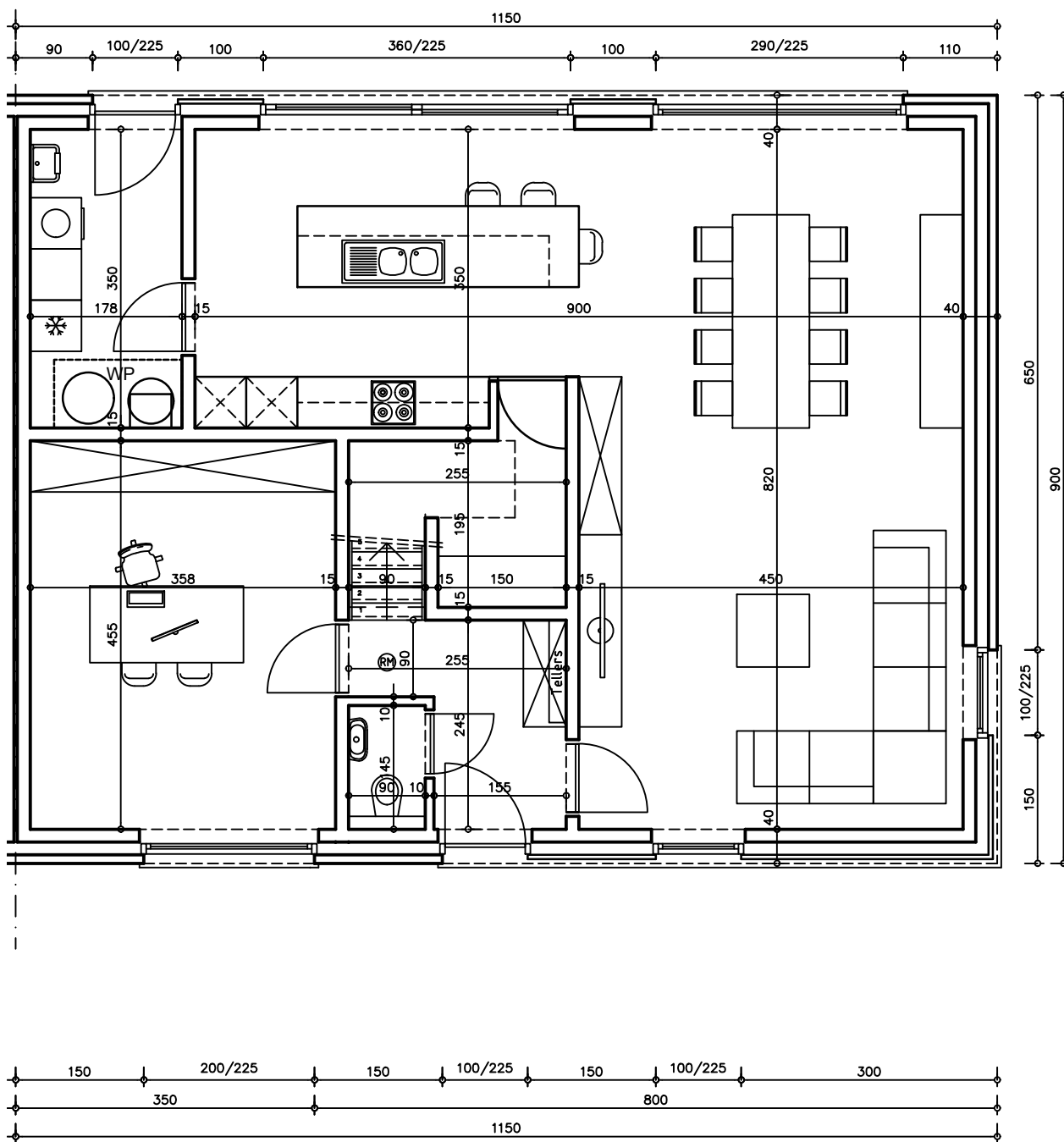

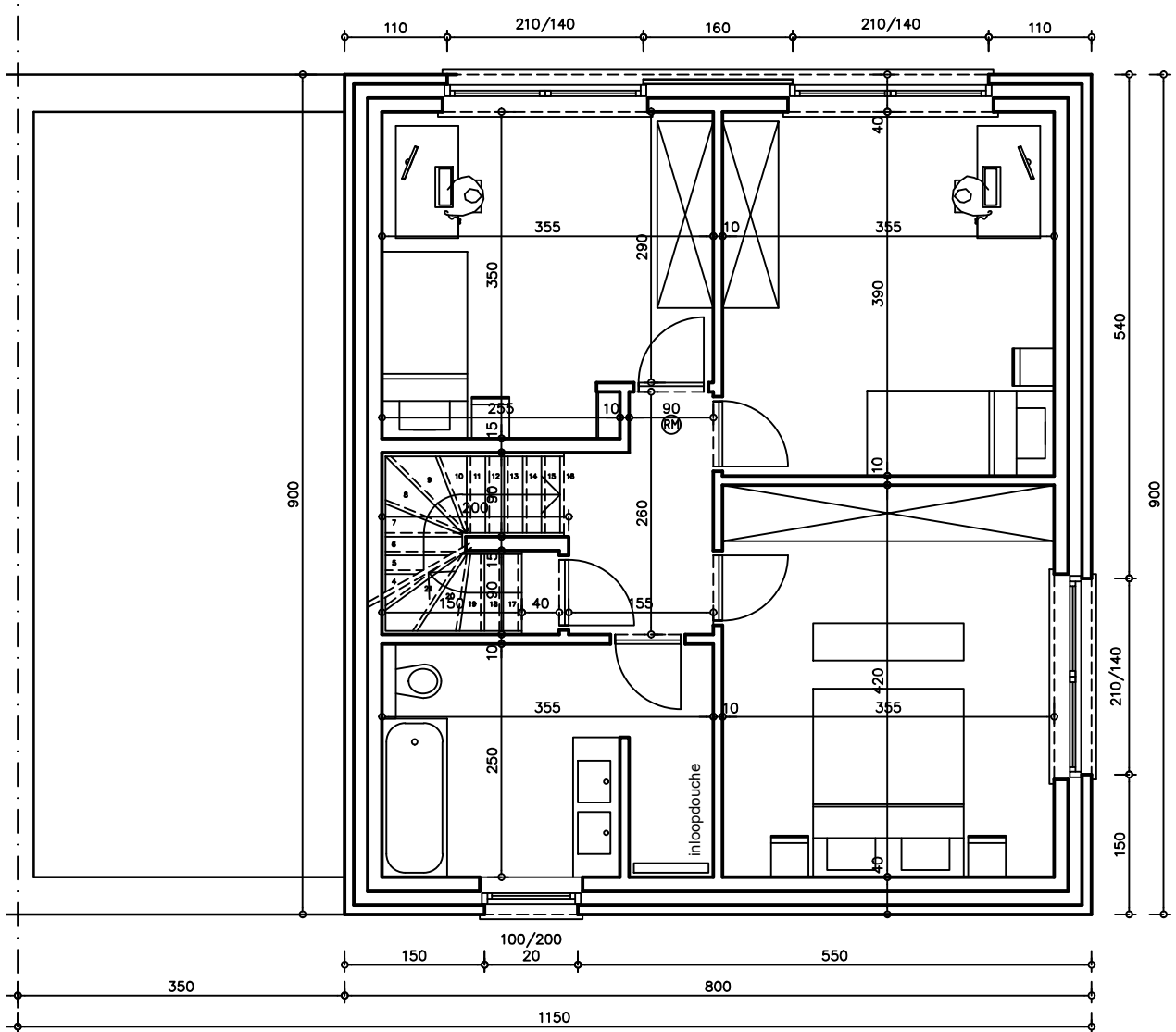

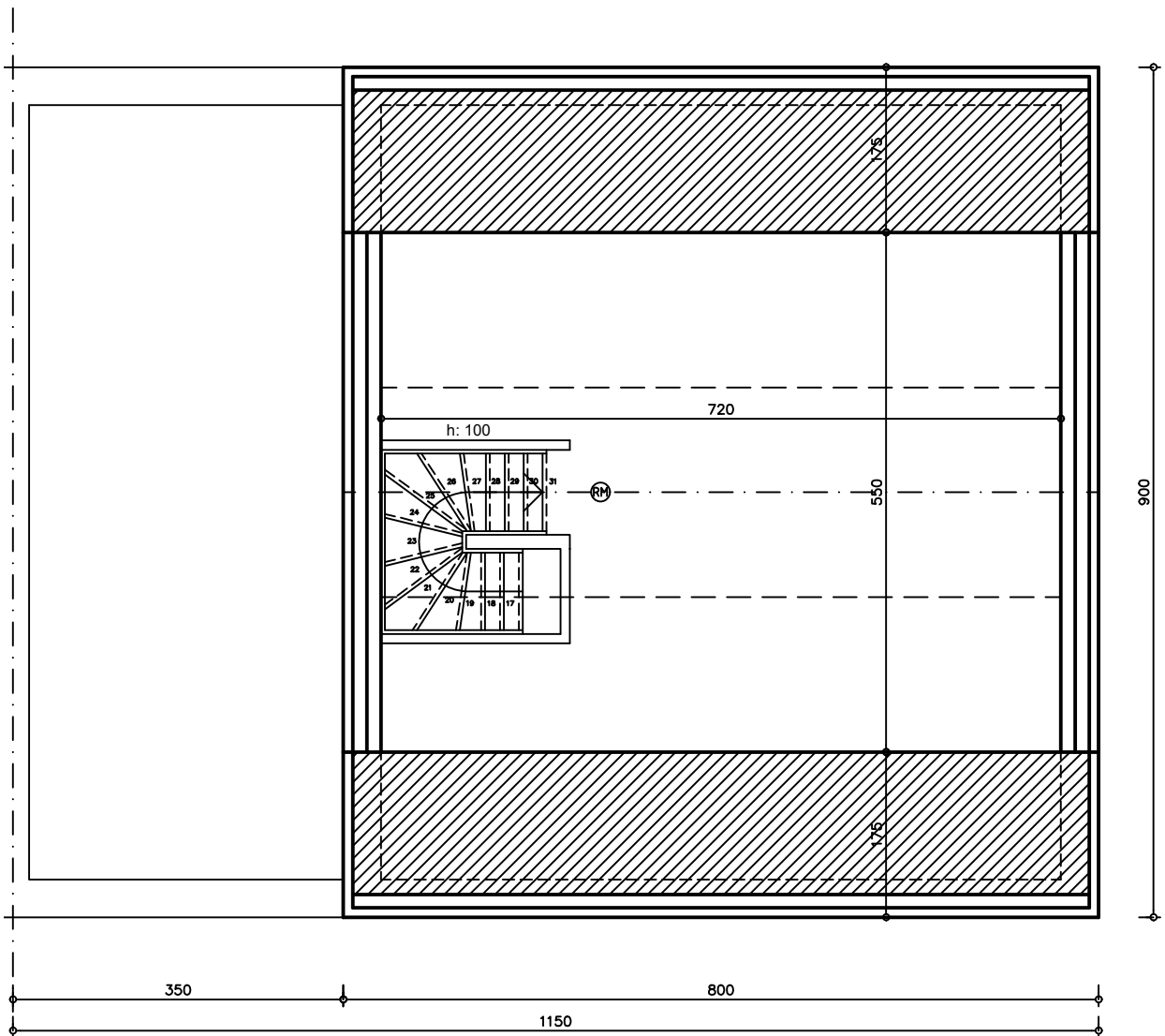

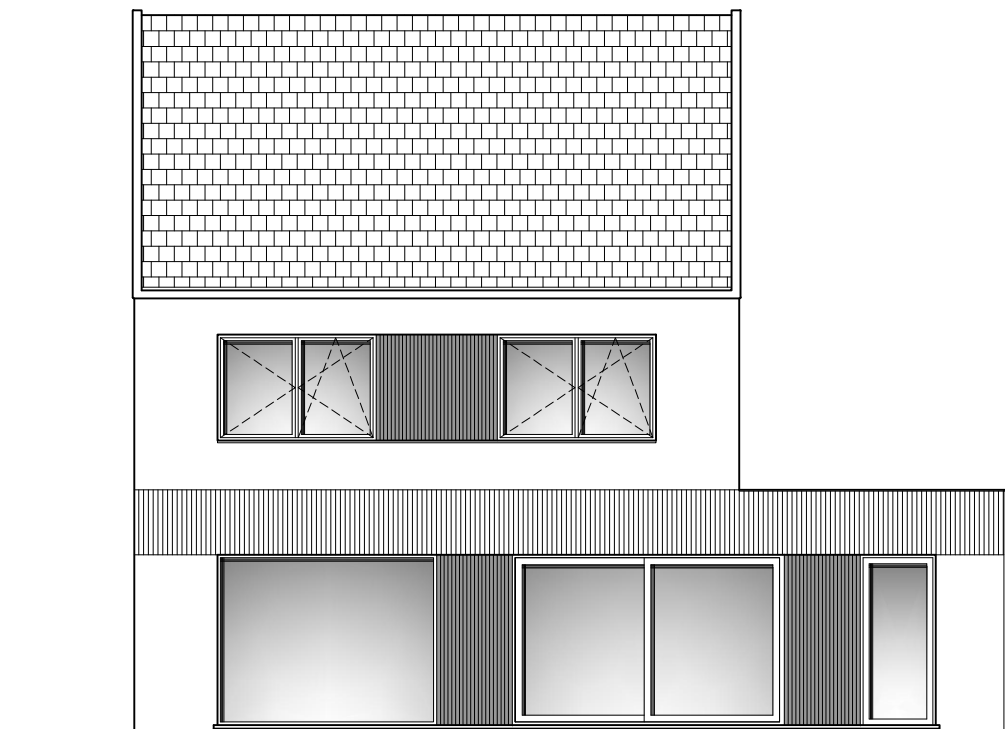
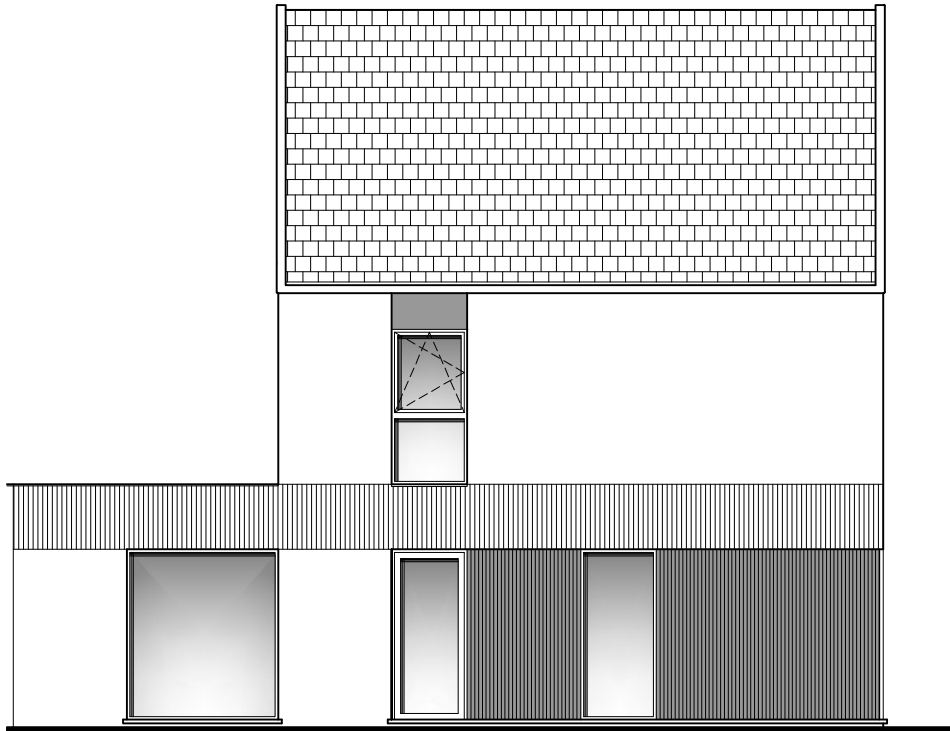

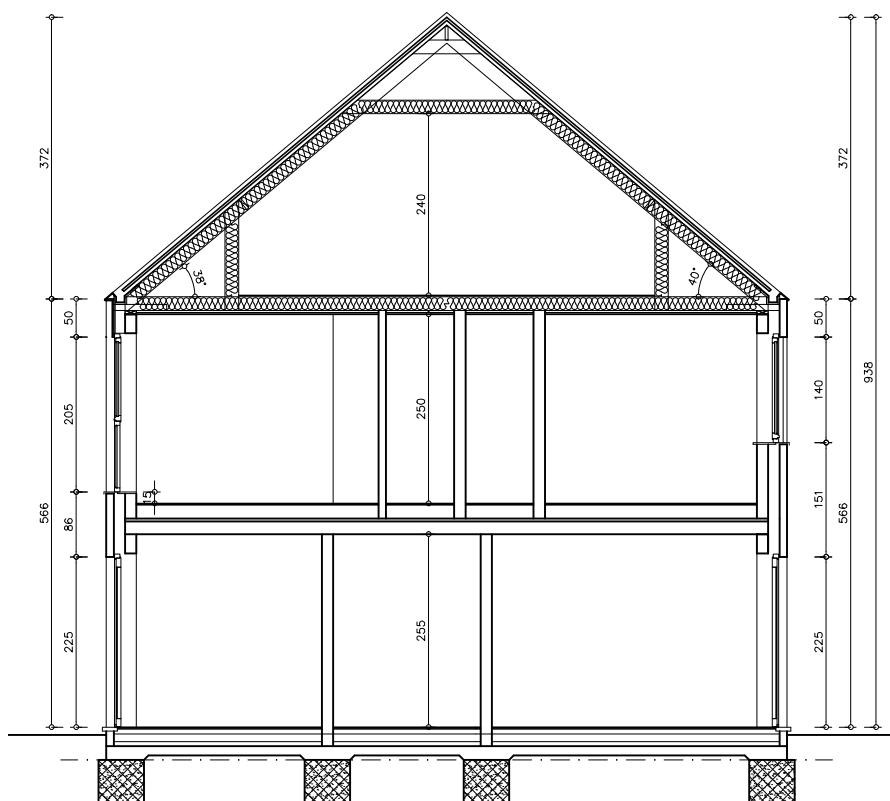
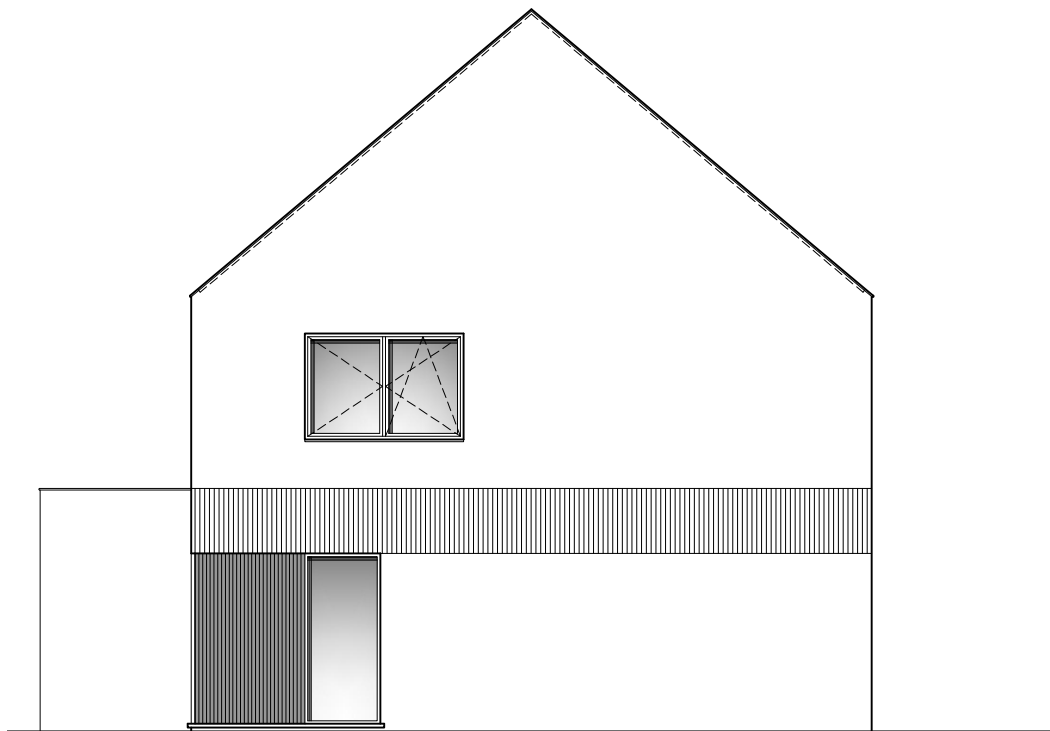

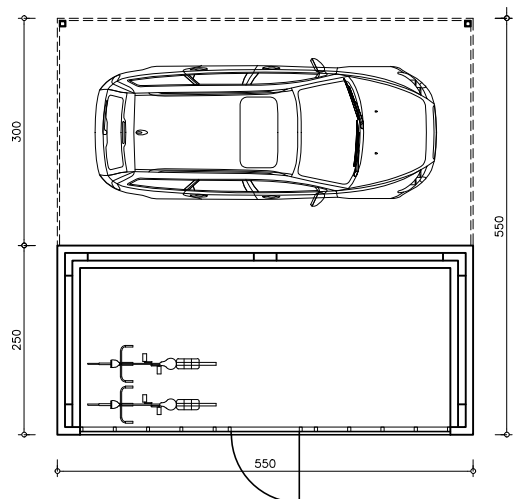

Grondplan

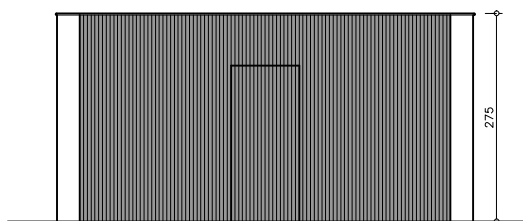

Voorgevel

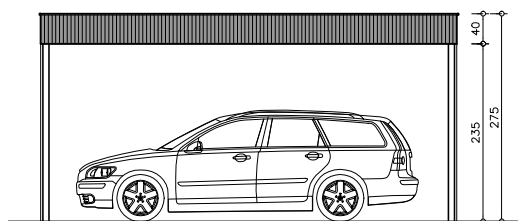

Achtergevel

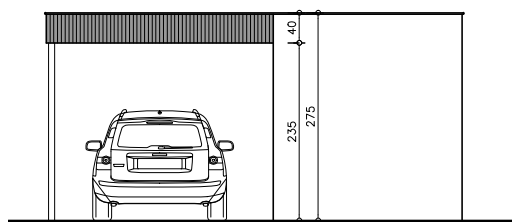

Zijgevel Links

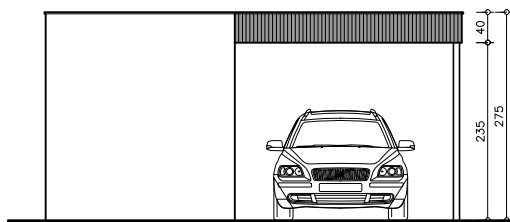

Zijgevel Rechts

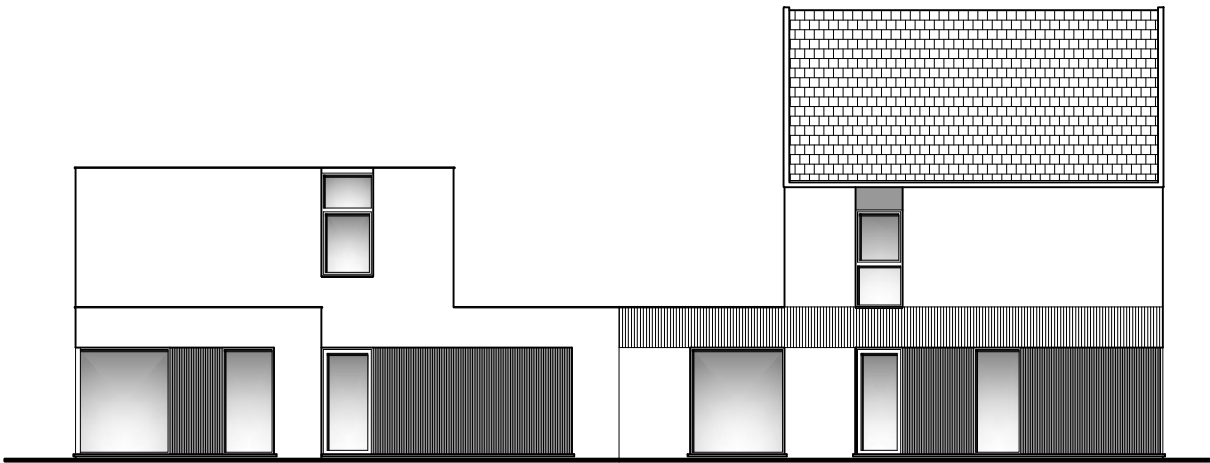

PLANNEN WONING

Eeklo, Oostveldstraat

LOT 2 - 3

Uw bouwadviseur

Ewout Vanden Bussche

T 0497 588 888 M ewout@huysmanbouw.be

Huysman Bouw

Stationsstraat 83
9900 Eeklo

Registratienummer
aannemer:
446.279.182/06/11/13

BTW:
BE 0446.279.182
RPR Gent

Bank AXA IBAN:
BE98 7030 3211 8293
BIC: AXABBE22

Bank ING IBAN:
BE96 3900 3251 9105
BIC: BBRUBEBB